

Revive Your Rusty Relics: The PDP Class Project Resolving An Old Machine

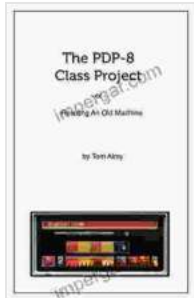

The PDP-8 Class Project: Resolving An Old Machine

by Tom Almy

★★★★☆ 4 out of 5

Language : English
File size : 4958 KB
Text-to-Speech : Enabled
Screen Reader : Supported
Enhanced typesetting : Enabled
Print length : 94 pages
Lending : Enabled



Restore and Repair Your Old Machines with Expert Guidance

Old machines hold a certain charm and nostalgia that can be hard to resist. Whether it's a vintage car, an antique sewing machine, or a cherished piece of industrial equipment, the prospect of restoring these relics to their former glory can be both daunting and exhilarating.

The PDP Class Project: Resolving an Old Machine is here to guide you through the intricate process of machine restoration and repair. This comprehensive book provides everything you need to know to tackle even the most challenging projects.

Step-by-Step Instructions

The PDP Class Project takes a practical approach to machine restoration, providing detailed, step-by-step instructions for every aspect of the process. From disassembly and cleaning to part replacement and reassembly, the book walks you through each step clearly and concisely.

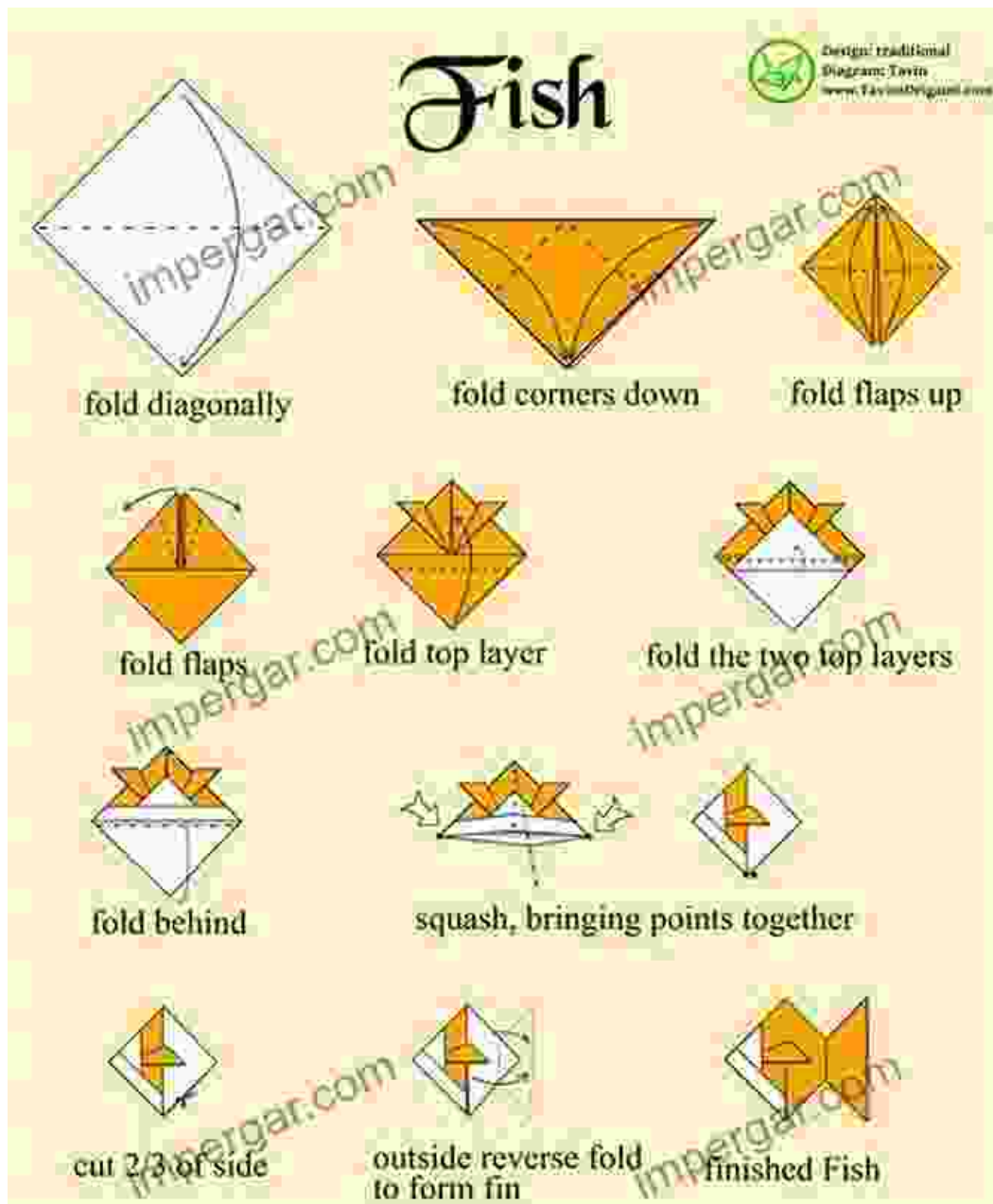

Detailed Diagrams

To complement the instructions, the book features numerous detailed diagrams that illustrate every step of the process. These diagrams are

invaluable for visualizing the machine's components and understanding how they interact.

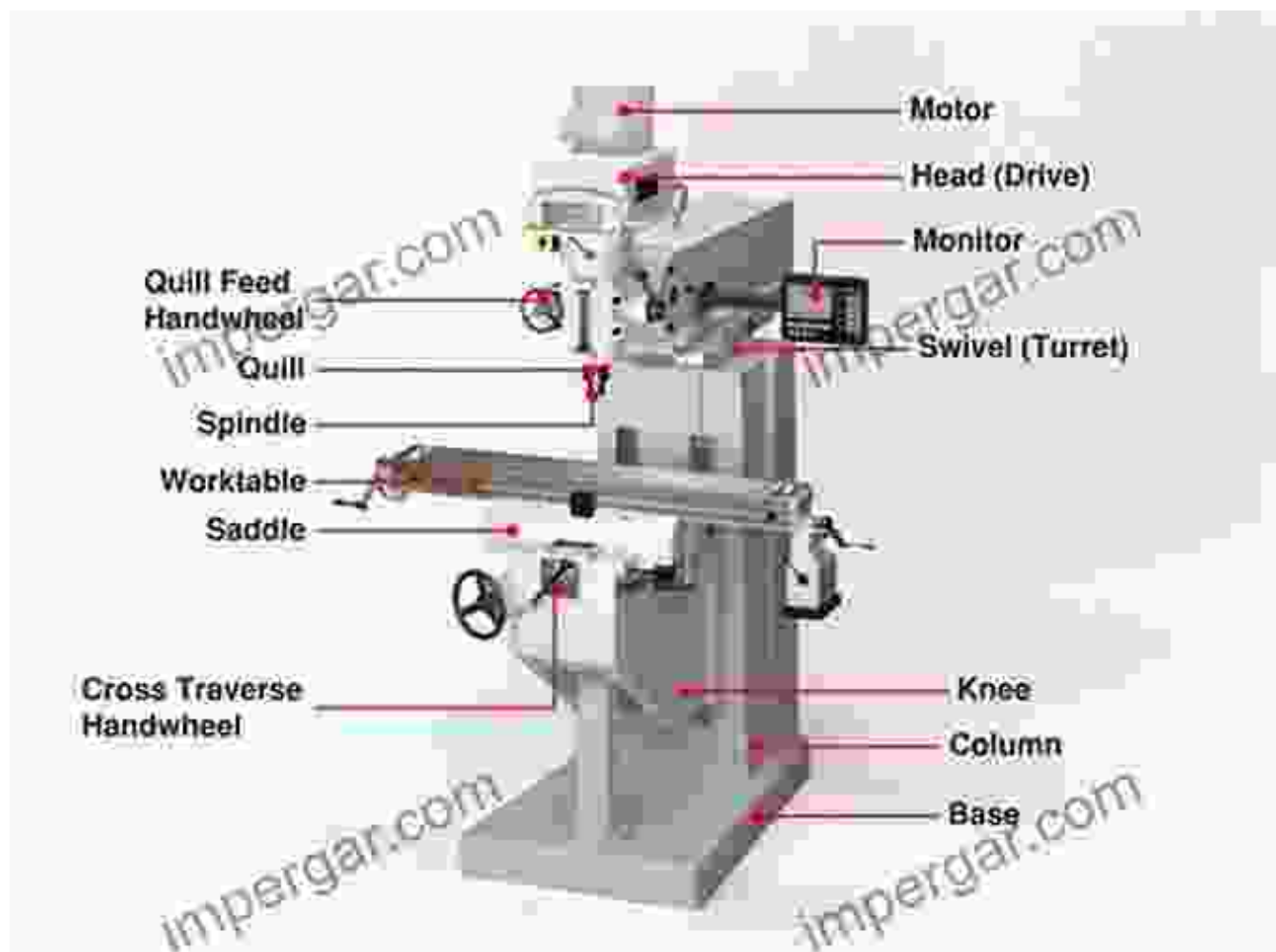

Expert Advice

The PDP Class Project draws on the expertise of experienced machinists and restorers to provide invaluable advice throughout the book. These tips and tricks will help you avoid common pitfalls, solve problems, and achieve the best possible results.

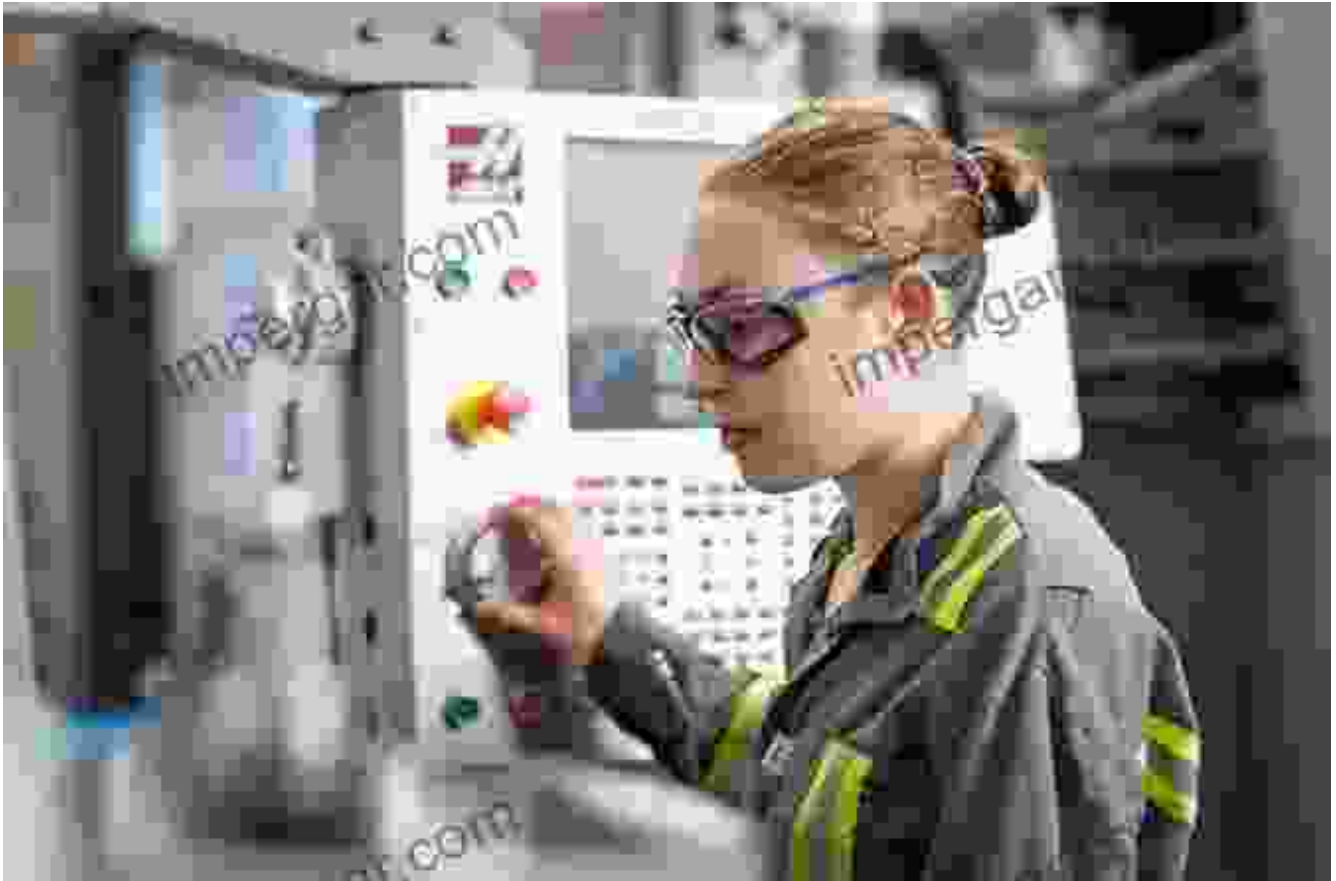

Case Studies

To demonstrate the practical application of the book's principles, the PDP Class Project includes several detailed case studies. These case studies cover a wide range of machines, from a vintage motorcycle to an industrial lathe.

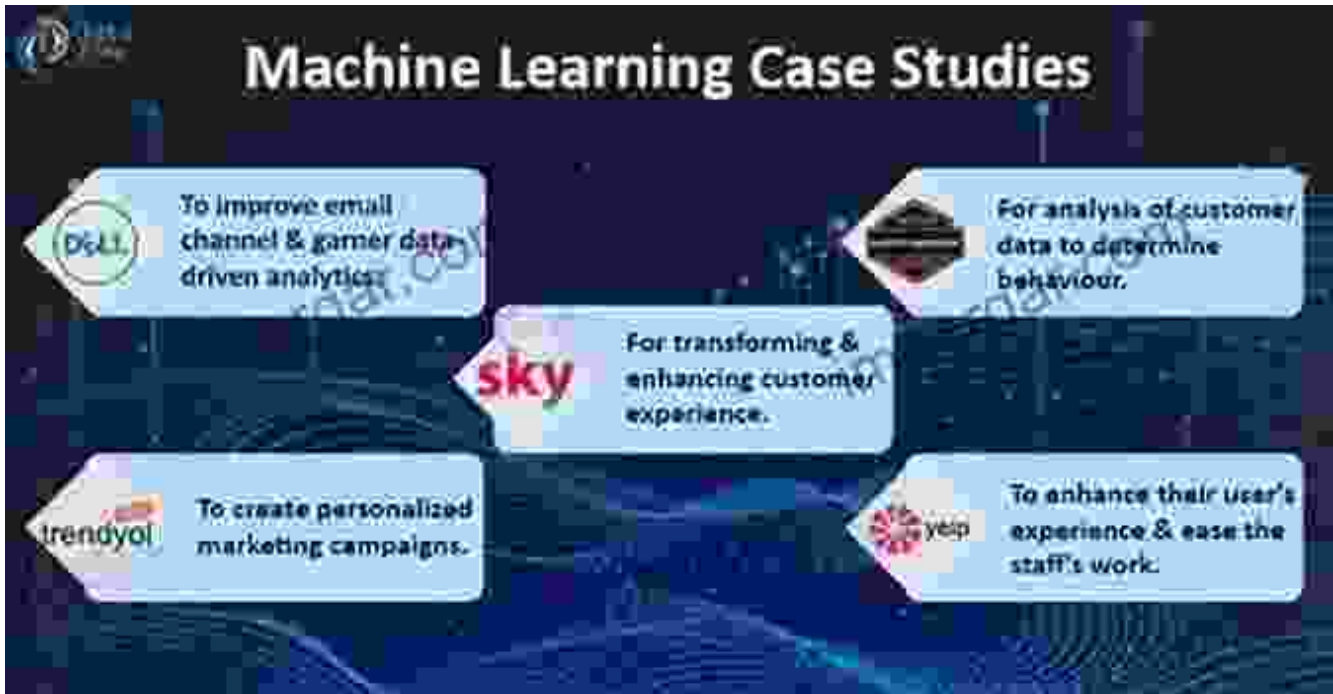

The PDP Class Project: Resolving an Old Machine is an essential resource for anyone interested in restoring and repairing old machines. This comprehensive guide provides everything you need to know to bring your rusty relics back to life and enjoy them for generations to come.

Free Download your copy of The PDP Class Project today and start your journey to machine restoration mastery!

Free Download Your Copy Today!

Get Your Copy Now

Copyright © [Your Name] 2023

The PDP-8 Class Project: Resolving An Old Machine

by Tom Almy

★★★★☆ 4 out of 5

Language : English

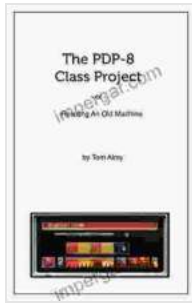

File size : 4958 KB
Text-to-Speech : Enabled
Screen Reader : Supported
Enhanced typesetting : Enabled
Print length : 94 pages
Lending : Enabled

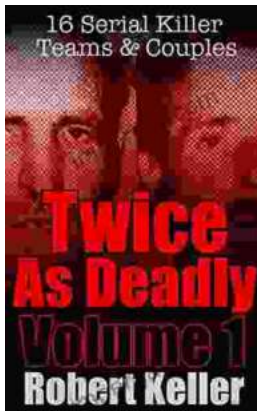

16 Serial Killer Teams and Couples: A Spine-Chilling Journey into Murderous Duo

From the annals of true crime, the stories of serial killer teams and couples stand out as particularly disturbing and captivating. These...

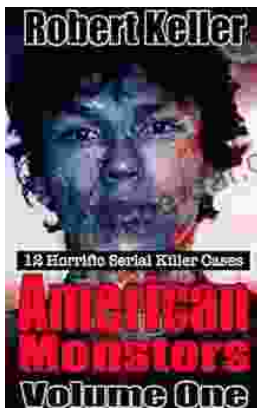

12 Horrific American Serial Killers: A Spine-Chilling Journey into the Depths of Evil

Immerse yourself in the darkest recesses of humanity with 12 Horrific American Serial Killers. This gripping book takes you on a chilling journey into the twisted minds of some...